

A.SHOW FC

230W Single-Source LED

- 230W / 4 color LED
- 9.000lm luminous flux
- IP66 In/Outdoor

ROXX® Architectural SHOW Series offers very high performance, weatherproof fixtures and features Single-Source-LEDs that produce an incredibly smooth lighting and uniform colors, providing a solution for any requirement. The LED variations range from a Tunable White over to a Full Color to a pure Tungsten and up to a Daylight version. Each one reaching an exceptionally good light quality with high CRI / TLCI and a massive light luminosity. The A.SHOW FC (Full Color) convinces with strong, saturated colors, great white light quality and a super balanced, luminous light without any color shadows. Adding Lime closes the gap between RGB, extending the color spectrum and improving the white light quality. For consistent colors and excellent whites as defined by the black body curve, ROXX® Color Calibration performs color matching across the entire range. Thanks to the specially developed ROXX® R.LOK technology, the lenses are protected against unauthorized changes but when needed are easily exchangeable. This allows the beam angle to be conveniently adjusted, whether from 17°, 35°, 59° or elliptical 16°x24° and 18°x57°. The A.SHOW Series is IP66 certified and features additional C5-M corrosion protection thus proving to be the perfect fixture even in difficult environments like coastal or offshore areas. The power inputs as well as the DMX & 0-10V I/O are realised via cable glands and Phoenix connection blocks for an individual and comfortable installation. Covering all possible requirements, the fixture includes an extensive range of accessories including 8-Way Barndoor, Honey Comb, Anti-Glare Shield, various lenses, Gel Frame and the R.KEY which is a tool that was designed for ROXX® especially to fit all pig-nose tilt locks of the architectural fixtures.

Accessories



Lenses



Accessory Holder



8-Way Barndoor



Honey Comb



R.KEY



Gel Frame



Full Anti-Glare Shield



Technical Data

Photometrics	
LED expected lifetime	50.000 hours
Lightsource	1x230W RGBL
Type of optical system	reflector + interchangeable lens plates
LED PWM Frequency	selectable 800Hz, 1200Hz, 2000Hz, 3600Hz, 12kHz, 25kHz
Beam angles (50%)	17° (with narrow lens) 35° (with medium lens) 59° (with wide lens) 16°x24° (with elliptical narrow lens) 18°x57° (with elliptical wide lens)
Maximum Field angles (10%)	34° (with narrow lens) 70° (with medium lens) 88° (with wide lens) 34°x45° (with elliptical-narrow lens) 42°x80° (with elliptical-wide lens)
Color temperature range	2.000K - 10.000K
CRI/Ra	85
TLCI	77
Efficacy (max)	47,61 lm/W
Luminous flux	9.219 lm
illuminance Lux @ 5m (narrow lens)	1.439 lx
illuminance Lux @ 5m (medium lens)	349 lx
illuminance Lux @ 5m (wide lens)	183 lx
illuminance Lux @ 5m (elliptical-narrow lens)	876 lx
illuminance Lux @ 5m (elliptical-wide lens)	372 lx
Thermal Characteristics	
Cooling	Active, Forced Air, Temperature-regulated
Humidity (max.)	95%
Temperature range, Operating	-20°C to 45°C
Temperature range, Start-up	-20°C to 50°C
Temperature range, Storage	-20°C to 80°C
Thermal Protection	Automatic overtemperature protection
Electrical Data	
AC power, max.	90 – 305V 50/60Hz
AC Power, nominal	100 – 277V 50/60Hz
Electrical Protection	Overload protection with automatic recover
Max Inrush Current	50A
Max power consumption	230W
Typical power consumption	154W
Standby power	6,7W
Max power thru @ 100V	8A
Max power thru @ 230V	8A
Power factor	0,92 PF (230 V) / 0,99 PF (100V)
Power Supply Unit	Inbuilt auto-ranging electronic switch-mode
Power Linking	4 units @ 120V; 8 units @ 230V
Operator & Controller	
DMX channels	3/10CH HSI, 3CH CCT, 3/6/9/11/14CH RGB, 6/12/13/20CH DIRECT
DMX modes	12

Technical Data

Protocol	CRMX, W-DMX™ G2, W-DMX™ G3, W-DMX™ G4, W-DMX™ G4S USITT DMX512A RDM ANSI E1.20 Bluetooth (Low Energy)
Setting and addressing	OLED graphical display / 4 controls RDM ANSI E1.20
Standalone mode	Auto Program, Editor, Color Macro, Quick Color, Tunable White, User Color, Timer
Wireless DMX	Lumenradio with RDM (CRMX)
Indicator	OLED graphical display
Controls	4 touch sensitive, backlighted controls
Strobe	0-20Hz
DMX & 0-10V I/O	cable bushing thru IP66 rated PG connection, including Phoenix type terminal block
Power Input	cable bushing thru IP66 rated PG connection, including Phoenix type terminal block
Dimensions & Weight	
IP class	IP 66
Net Dimensions (w x h x d)	231 x 311 x 258 mm
Physical Head Straight Up Height	339 mm
Net Dimensions inches	9,1 x 12,2 x 10,1 inches
Net Weight	5,7 kg (12,6 lbs)
Included / Optional	
Included items	2x radiator caps for pendant installation 2m power cable
Color options	White – RAL 9010 Black – RAL 9004 (Standard) Custom color – any RAL

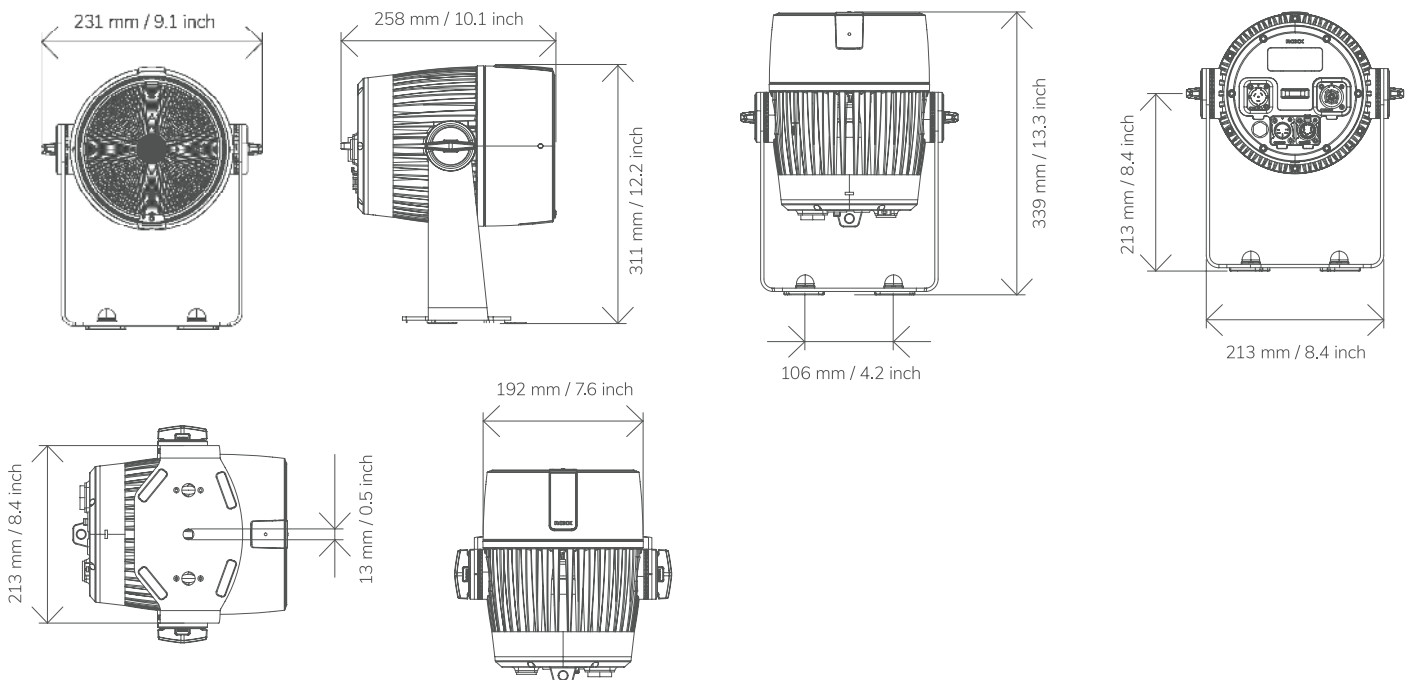

Luminaire Photometrics

Narrow Lens

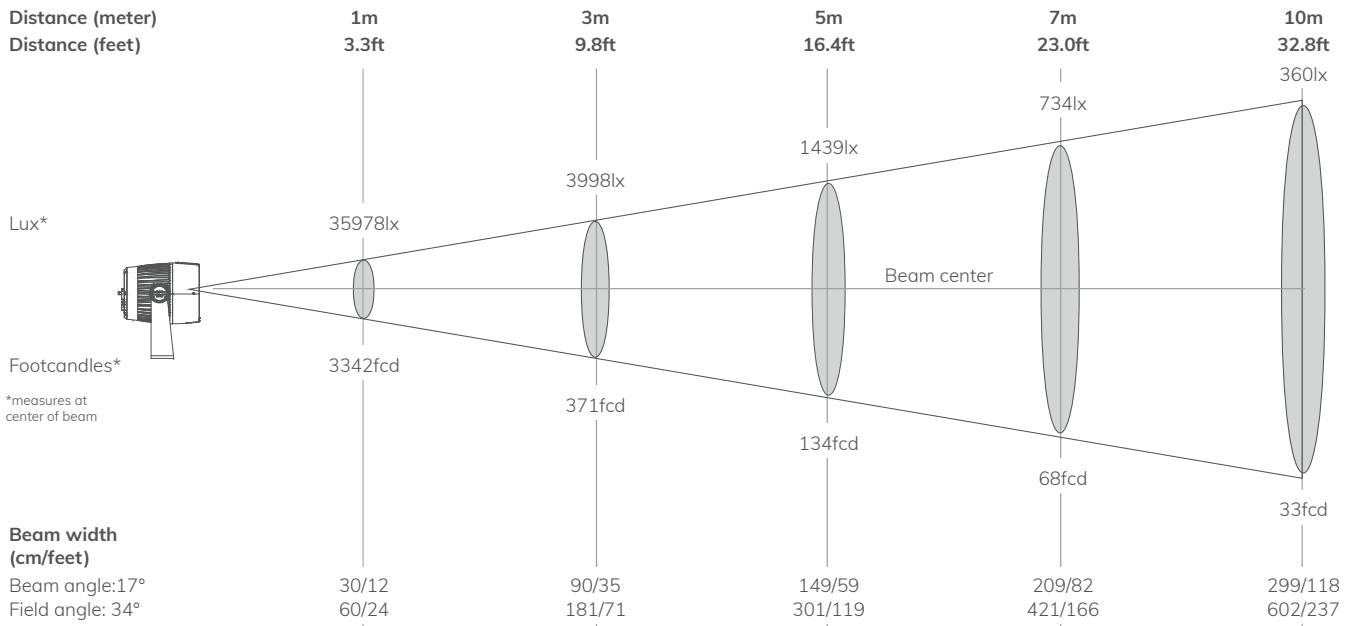

Lens	Angle	Distance									
		1m/3.3ft		3m/9.8ft		5m/16.4ft		7m/23ft		10m/32.8ft	
		Lux Center lx/fcd	Diameter cm/inch	Lux Center lx/fcd	Diameter cm/inch	Lux Center lx/fcd	Diameter cm/inch	Lux Center lx/fcd	Diameter cm/inch	Lux Center lx/fcd	Diameter cm/inch
N	Beam angle: 17°	35978/ 3342	30/12	3998/ 371	90/35	1439/ 134	149/59	734/ 68	209/82	360/ 33	299/118
	Field angle: 34°		60/24		181/71		301/119		421/166		602/237
M	Beam angle: 35°	8707/ 809	63/25	968/ 90	190/75	347/ 32	316/124	178/ 17	443/174	87/ 8	633/249
	Field angle: 70°		141/56		422/166		703/277		984/387		1406/554
W	Beam angle: 59°	4561/ 424	111 /44	507/ 47	334/131	182/ 17	557/219	93/ 7	779/307	46/ 4	1113/438
	Field angle: 88°		191/75		574/226		957/377		1340/528		1915/753
EN	Beam angle: 16°x24°	21886/ 2033	28x42/ 11x17	2432/ 226	85x125/ 33x49	876/ 81	142x209/ 56x82	447/ 42	199x292/ 78x115	219/ 20	285x418/ 112x165
	Field angle: 34°x45°		61x83/ 24x33		184x250/ 72x98		307x417/ 121x164		429x584/ 169x230		613x835/ 241x328
EW	Beam angle: 18°x57°	9303/ 864	31x108/ 12x43	1034/ 96	93x323/ 37x127	372/ 35	155x538/ 61x212	190/ 18	217x754/ 85x297	93/ 9	310x1077/ 122x424
	Field angle: 42°x80°		76x168/ 30x66		228x505/ 90x199		380x842/ 150x331		532x1179/ 209x464		760x1684/ 299x663

Order Number

A.SHOW FC	Order Number
A.SHOW FC Black	11302101
A.SHOW FC White	11302102
A.SHOW FC Custom	11302103
Accessories	Order Number
A.SHOW Lens N (Narrow)	11307005
A.SHOW Lens M (Medium)	11307105
A.SHOW Lens W (Wide)	11307205
A.SHOW Lens EN (Elliptical Narrow)	11307305
A.SHOW Lens EW (Elliptical Wide)	11308205
A.SHOW Accessory Holder	11307401

Accessories	Order Number
A.SHOW Barndoor	11307501
A.SHOW Honey Comb	11907601
Gel Frame	11907701
R.KEY	11990013
SHOW Full Anti-Glare Shield (White)	11208402
SHOW Full Anti-Glare Shield (Custom Color)	11208403

Further Versions



A.SHOW TW+



A.SHOW D



A.SHOW T

